

MPS Series Magnetic Proximity Sensors

Features/Benefits

- Long life—4M operations
- Sealed contacts
- Quality construction
- Quick and easy installation

Typical Applications

- Automotive sensors and indicators
- Industrial sensors
- Factory automation equipment



Specifications

CONTACT RATINGS: 3.0 W max. @ 30 V DC or 30 V AC max. @ 0.3 AMP max.; 1.0 msec. max. operate time (including bounce); 1.0 AMP max. carry current.

CONTACT RESISTANCE: 100 m Ω max. initial.

DIELECTRIC STRENGTH: 200 V DC min.

ELECTRICAL CIRCUIT: SPST NO (Contact Form A). Reed switch opens when magnet is removed from proximity. Contacts are held closed when magnet is within actuation range.

OPERATING TEMPERATURE: -40°F to 212°F (-40°C to 100°C).

OPERATING DISTANCE/ALIGNMENT: Operate (pull-in or make) points are nominal values with $\pm 10\%$ tolerance. Release points are 110% to 150% of the operating points.

MECHANICAL & ELECTRICAL LIFE: 4 million operations.

PACKAGING: Bulk packaging, 10 switch and magnet pairs per package.

Materials

HOUSING/SPACER/COVER: ABS plastic (UL94V-0), white.

REED SWITCH: Rhodium coated reed contacts in hermetically sealed, nitrogen filled glass capsule. Closed when magnet is in close proximity. Used in closed loop circuits.

WIRE LEADS: UL 1061, 22 AWG wire: stranded, made of copper or aluminum; Length: 12 in. with ends stripped; Color: white.

POTTING (around wires): Epoxy.

MAGNETS: MPS45WGW: NdFeB

MPS80WGW: Ceramic Ferrite 8

All other models: Alnico V

ADHESIVE MOUNTING: Foam-backed, pressure-sensitive adhesive with release liner (MPS45WGW model only).

NOTE: Specifications and materials listed above are for switches with standard options. For information on specific and custom switches, consult Customer Service Center.

How To Order

Complete part numbers for MPS Series Magnetic Proximity Sensors are shown on pages E-35 thru E-39.

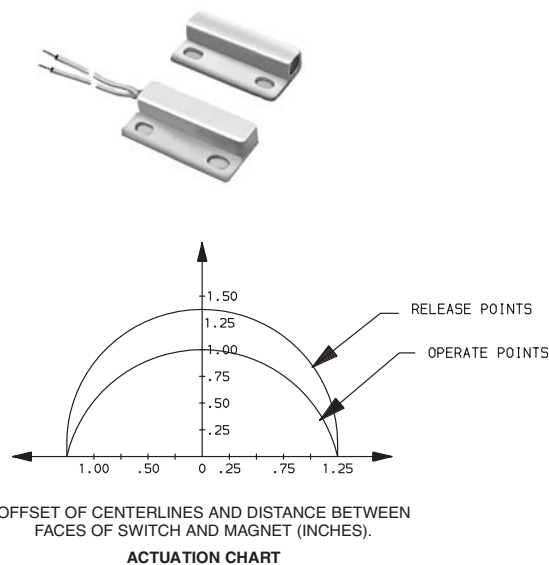

NOTE: UL 61058-2 Rating

| PART NUMBER | SWITCH TYPE |
|-----------------|--|
| MPS45WGW | Subminiature surface mount (adhesive or flange), side exit leads, 1" make gap. |

UL 61058-2

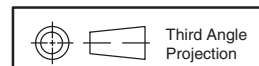
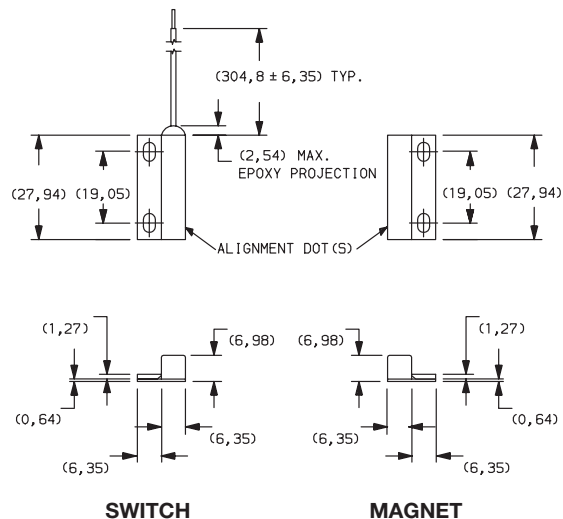

Dimensions are shown in mm
Specifications and dimensions subject to change



MPS Series Magnetic Proximity Sensors

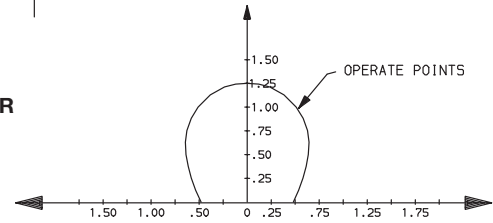
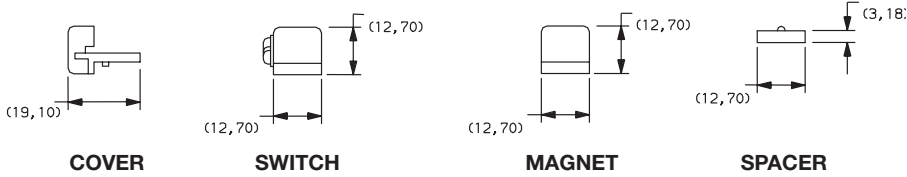
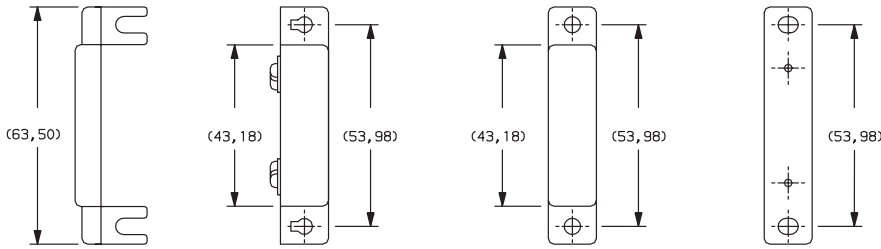

OFFSET OF CENTERLINES AND DISTANCE BETWEEN FACES OF SWITCH AND MAGNET (INCHES).
ACTUATION CHART

| PART NUMBER | SWITCH TYPE |
|-----------------|---|
| MPS20WGW | Standard surface mount, screw terminals, 1 1/4" make gap. |

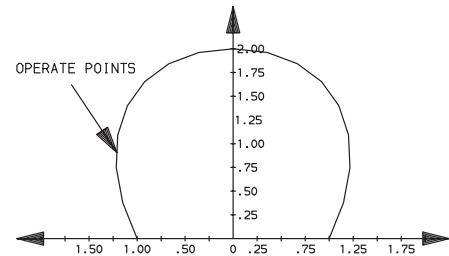
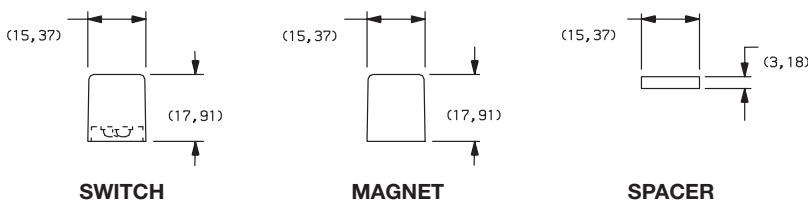
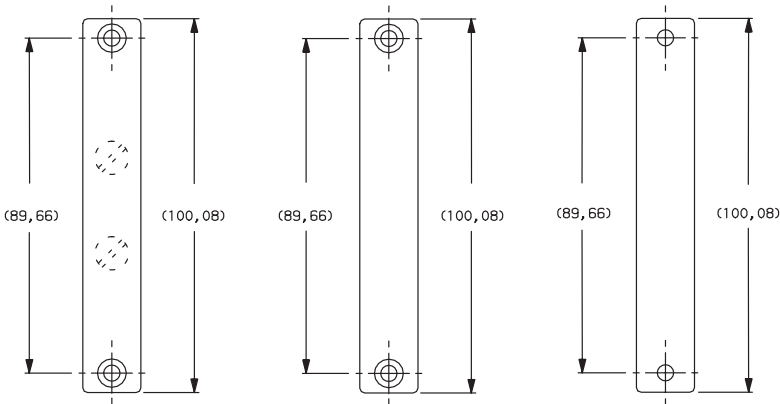

OFFSET OF CENTERLINES AND DISTANCE BETWEEN FACES OF SWITCH AND MAGNET (INCHES).
ACTUATION CHART

| PART NUMBER | SWITCH TYPE |
|-----------------|---|
| MPS80WGW | Industrial surface mount, concealed screw terminals, 2" make gap. |



Detect

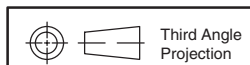

Dimensions are shown: mm
Specifications and dimensions subject to change



MPS Series Magnetic Proximity Sensors

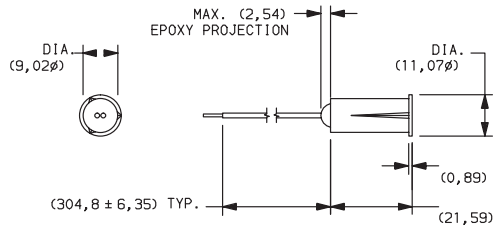

SWITCH

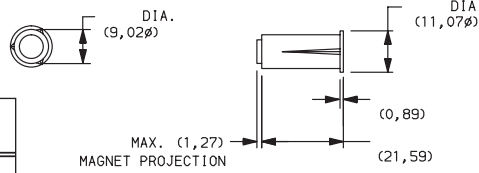

MAGNET

| PART NUMBER | SWITCH TYPE |
|----------------|---|
| MPS95GW | 3/8" Diameter recessed magnetic contact, 1 1/4" make gap. |

**SWITCH & MAGNET
PANEL MOUNTING**

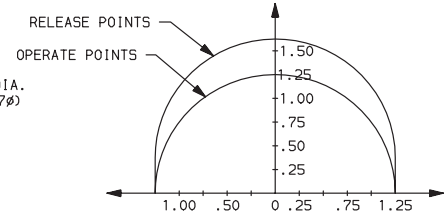
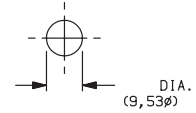

OFFSET OF CENTERLINES AND DISTANCE BETWEEN FACES OF SWITCH AND MAGNET (INCHES).

ACTUATION CHART

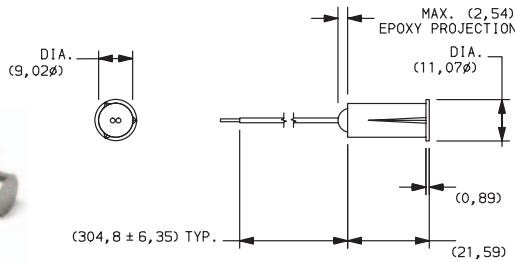

SWITCH

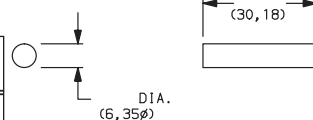

MAGNET

| PART NUMBER | SWITCH TYPE |
|----------------|---|
| MPS95GW | 3/8" Diameter recessed magnetic contact, 1 1/4" make gap. |

**SWITCH
PANEL MOUNTING**

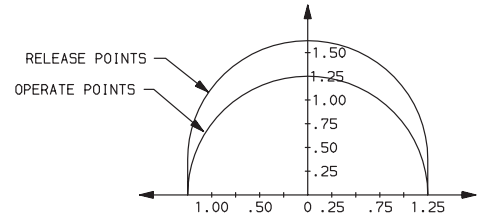
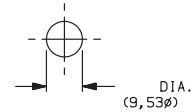

OFFSET OF CENTERLINES AND DISTANCE BETWEEN FACES OF SWITCH AND MAGNET (INCHES).

ACTUATION CHART



Third Angle Projection

Dimensions are shown: mm
Specifications and dimensions subject to change



MPS Series Magnetic Proximity Sensors

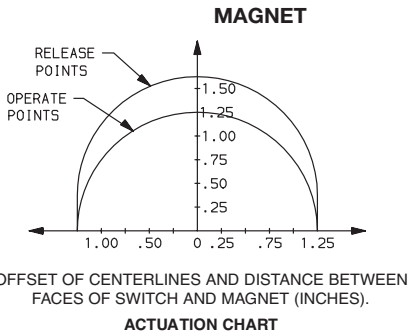
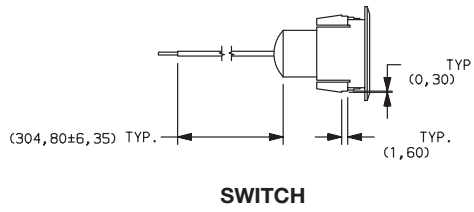
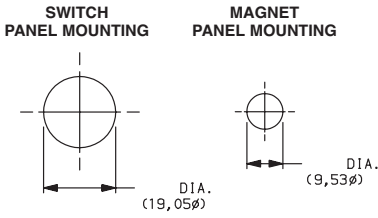
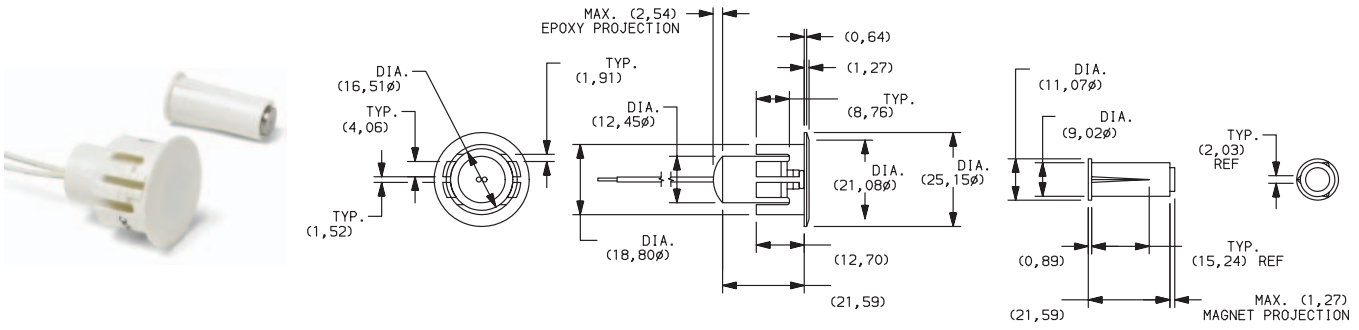

| PART NUMBER | SWITCH TYPE |
|-----------------|---|
| MPS73WGW | 3/4" Diameter recessed magnetic contact, 1 1/4" make gap. |

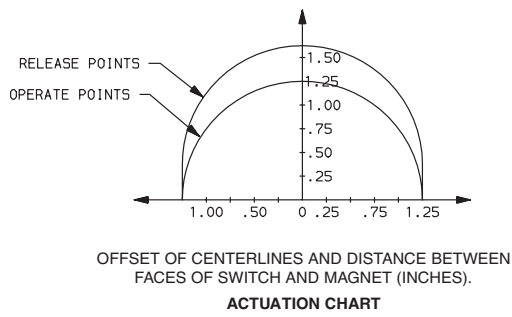
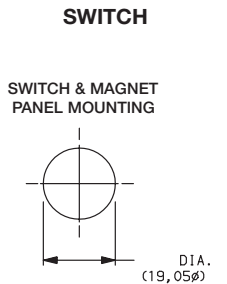
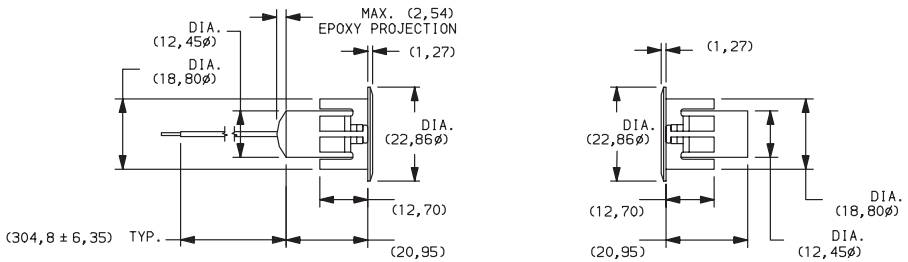

| PART NUMBER | SWITCH TYPE |
|-----------------|---|
| MPS70WGW | 3/4" Diameter recessed magnetic contact, 1 1/4" make gap. |

Detect

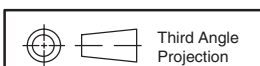

Dimensions are shown: mm
Specifications and dimensions subject to change



MPS Series Magnetic Proximity Sensors

Actuating Positions

When installing recessed and surface mount contacts, magnet position is very important. The switch and magnet must always be parallel or end to end, and never in a 'T' configuration.

Gap Distance

Gap distance is a combination of the horizontal and vertical plane separation of the switch and magnet. Example: if a recessed magnet is 1/4" off the centerline of the switch, the make gap is reduced by 1/4"

Correct Configuration

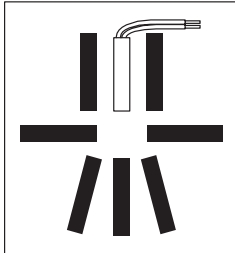

Incorrect Configuration

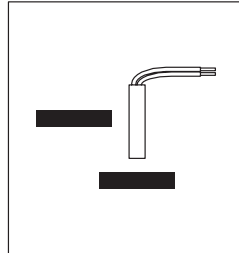

Center Alignment

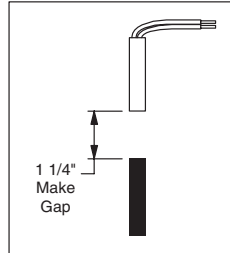

Off Center Alignment

