



# DA Series Miniature Single Pole Rocker Switches

## SWITCH FUNCTION

NO. POLES	MODEL NO.	SWITCH FUNCTION			CONNECTED TERMINALS			SCHEMATIC
SP	<b>DA101</b>	ON	NONE	ON	2-3	N/A	2-1	
	<b>DA102</b>	ON	NONE	OFF				 OR For 7 & 8 Illuminated Versions Only
	<b>DA103</b>	ON	OFF	ON				 For 6 Illuminated Versions Only

Shown in Pos. 1

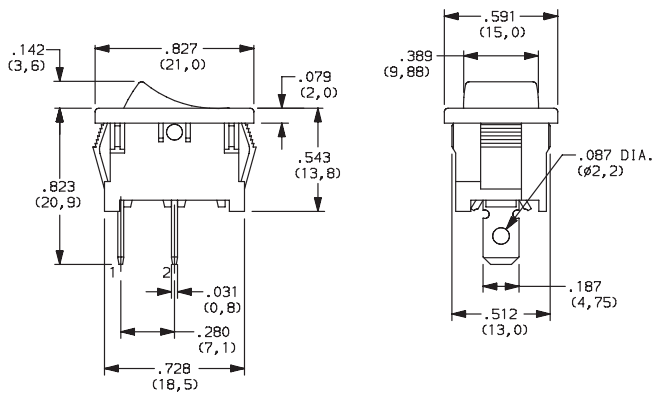

## ACTUATOR

- J1** ROCKER
- \*J3** ILLUMINATED ROCKER

- J2** TWO-TONE ROCKER

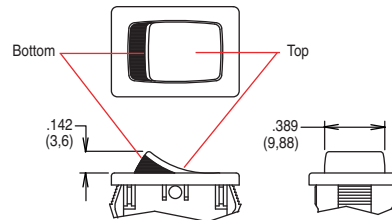
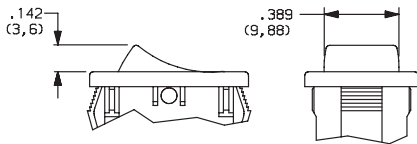

**NOTE:** J3 actuator available with DA102 switch functions, 7&8 lamp ratings and not available with O2 and A termination options.

**NOTE:**

1. Available with DA102 switch function only.
2. Available with None or P actuator marking options only.

Rocker



G

**C&K**



Third Angle Projection

Dimensions are shown: Inches (mm)  
Specifications and dimensions subject to change

# DA Series Miniature Single Pole Rocker Switches

## ACTUATOR

### J4 CIRCLE, ILLUMINATED ROCKER

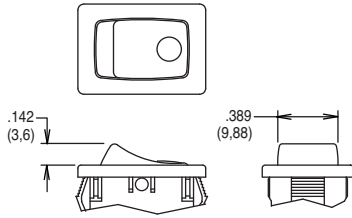

**NOTE:** Available with DA102 switch function and 7 & 8 lamp ratings combinations only. Not available with O2 and A termination options.

### J5 OVAL, ILLUMINATED ROCKER

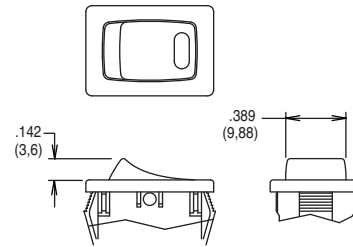

**NOTE:** Available with DA102 switch function and 6 lamp rating combinations only. Not available with O2 and A termination options.

## ACTUATOR COLOR

	OPTION CODE	ACTUATOR COLOR
<b>J1 only</b>	<b>2</b>	BLACK
	<b>1</b>	WHITE
	<b>3</b>	RED
<b>J3, J4, J5 only</b>	<b>R</b>	RED, ILLUMINATED
	<b>A</b>	AMBER, ILLUMINATED
	<b>G</b>	GREEN, ILLUMINATED

	OPTION CODE	ACTUATOR COLOR	
		TOP	BOTTOM
<b>J2 only</b>	<b>1</b>	WHITE	RED
	<b>2</b>	WHITE	BLACK
	<b>3</b>	RED	WHITE
	<b>4</b>	BLACK	WHITE
	<b>5</b>	BLACK	RED

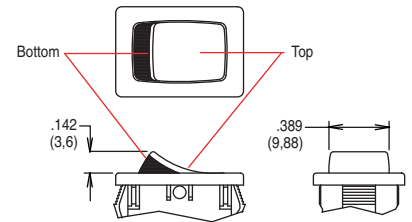

## MOUNTING STYLE/COLOR

### S2 SNAP-IN, BLACK

### S1 SNAP-IN, WHITE

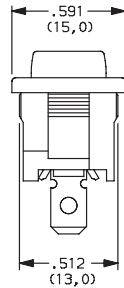
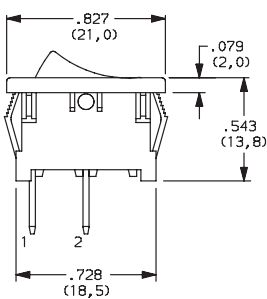

### G2 GUARD, BLACK

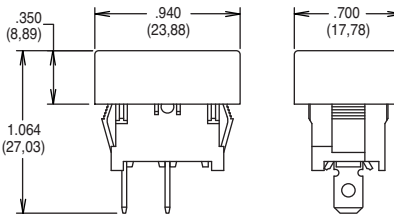

**NOTE:** Available with DA10X switch functions only.

### S2, S1 & G2 PANEL MOUNTING

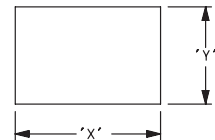

PANEL THICKNESS	"X"	"Y"
0.030-0.049 (0,75-1,25)	0.756-.004 (19,2-0,1)	0.512+.004 (13,0+0,1)
0.049-0.079 (1,25-2,0)	0.764-.004 (19,4-0,1)	0.512+.004 (13,0+0,1)
0.079-0.118 (2,0-3,0)	0.779-.004 (19,8-0,1)	0.512+.004 (13,0+0,1)

Actuator shown in Pos. 1

### B2 RECESSED SNAP-IN BRACKET, BLACK

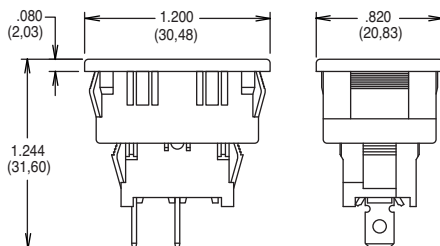

**NOTE:** Available with DA10X switch functions only.

### B2 PANEL MOUNTING

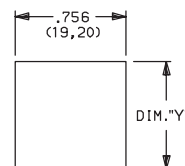

PANEL THICKNESS	"Y"
0.030-0.049 (0,75-0,25)	1.068 (27,13)
0.049-0.079 (1,25-2,0)	1.076 (27,33)
0.079-0.118 (2,0-3,0)	1.092 (27,74)

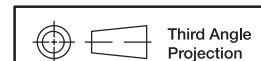

Third Angle Projection

Dimensions are shown: Inches (mm)

Specifications and dimensions subject to change



# DA Series Miniature Single Pole Rocker Switches

## TERMINATION

### 15 .187" QUICK CONNECT

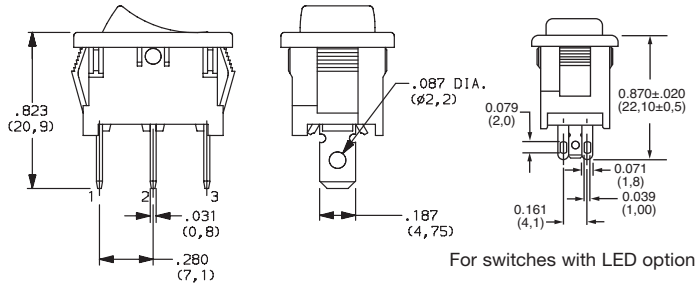

### 17 SOLDER LUG

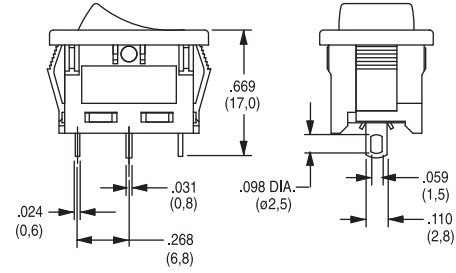

### 02\* THRU-HOLE

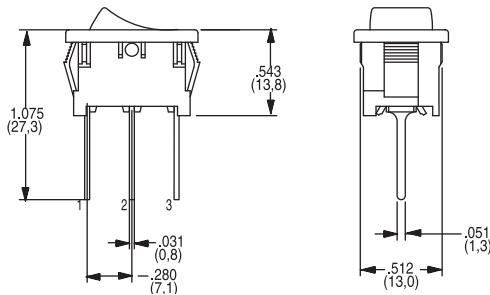

### A\* RIGHT ANGLE

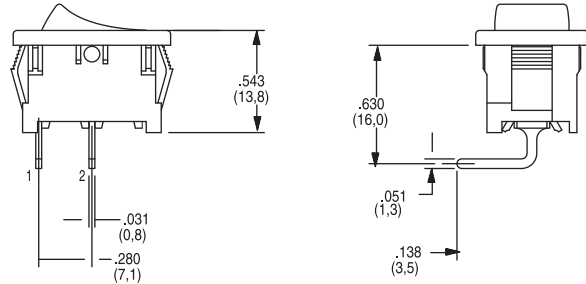

\* NOTE - O2 and A termination options not offered with J3, J4 or J5 actuator options.

## ACTUATOR MARKING

### NONE NO MARKING



### D ON-OFF



### H O I

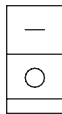

### N LARGE DOT



### P O -

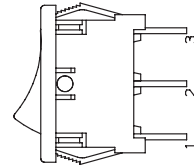

All models shown in Pos. 1  
Markings not available with J3 actuator

NOTE: Orientation of actuator marking and terminals.

## CONTACT MATERIAL

OPTION CODE	CONTACT AND TERMINAL MATERIAL	RATINGS	
QF	SILVER	POWER	16 AMPS @ 125 VAC; 1/3 HP; 10 AMPS @ 250 VAC; 1/2 10 AMPS @ 125 VAC, 6 AMPS @ 250 VAC

\* Note: See Technical Data section of this catalog for RoHS compliant and compatible definitions and specifications.

## LAMP RATING

### (NONE) NO LAMP

6 LED RATING @ 10 mA  $V_f=1.85V$

7 125 VAC 33kΩ NEON

8 250 VAC 150kΩ NEON

## ACCESSORIES

### 216C00000 IP65 SPLASH PROOF RUBBER BOOT

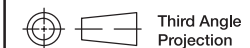
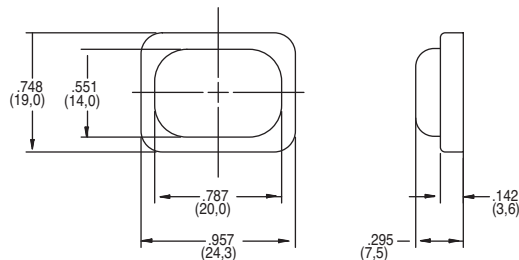

Third Angle Projection  
Dimensions are shown: Inches (mm)  
Specifications and dimensions subject to change

Rocker



G

**C&K**